

QUICK SELECTION / Selezione veloce

input speed (n_1) = 1400 min⁻¹

Output Speed n_2 [min ⁻¹]	Ratio i	Motor power P_{1M} [kW]	Output torque M_{2M} [Nm]	Service factor f.s.	Nominal power P_{1R} [kW]	Nominal torque M_{2R} [Nm]	Available B5 motor flanges		Available B14 motor flanges		Dynamic efficiency RD	Tooth Module [mm]	 Ratios code
							-A	-B	-O	-P			
							56	63	56	63			
280	5	0.18	5	3.3	0.60	17	B		B-C		82	1.26	09
200	7	0.18	7	2.4	0.44	17	B		B-C		80	1.44	01
140	10	0.18	10	1.8	0.32	17	B		B-C		78	1.44	02
93	15	0.18	13	1.4	0.25	19	B		B-C		73	1.44	03
70	20	0.18	17	1.1	0.20	19	B		B-C		70	1.09	04
47	30	0.12	15	1.4	0.17	21	B		B-C		62	1.44	05
35	40	0.12	19	1.1	0.13	20	B		B-C		57	1.09	06
23	61	0.09	19	1.1	0.10	20	B		B-C		50	0.72	07
17.5	80	0.06	16	1.0	0.06	16	B		B-C		48	0.56	08
14	100	0.06*	16	0.5	0.03	8	B		B-C		40	0.45	10

A) Motor Flanges Available
Flange Motore Disponibili

B) Supplied with Reduction Bushing
Fornito con Bussola di Riduzione

B) Available on Request without reduction bushing
Disponibile a Richiesta senza Bussola di Riduzione

C) Motor Flange Holes Position
Posizione Fori Flangia Motore

* Power higher than the maximum one which can be supported by the gearbox. Select according to the torque M_{2R}
Potenza superiore a quella massima sopportabile dal riduttore. Selezionare in base al momento torcente M_{2R}

EN Unit 030 is supplied with synthetic oil, providing "long life" lubrication. For mounting position V5-V6 please contact us.
See table 1 for lubrication and recommended quantity. In table 2 please see possible radial loads and axial loads on the gearbox.

LUBRICATION 030 Oil Quantity 0.03 Lt.

AGIP Telium VSF 320

SHELL Omala S4 WE 320

For all details on lubrication and plugs check our website **tab. 1**
Per maggiori dettagli su lubrificazione e tappi olio vedi il nostro sito web

I Il riduttore tipo 030 viene fornito lubrificato a vita con olio sintetico. Per posizioni V5-V6 contattare il ns. servizio tecnico.
Vedi tab.1 per oli e quantità consigliati. In tab.2 sono presenti i carichi radiali e assiali applicabili al riduttore.

D Für die Lebensdauerschmierung ist das Getriebe der Größe 030 mit synthetischem Öl befüllt. Bei Einbaulage V5 oder V6 bitten wir um Rücksprache. In Tabelle 1 ist die Schmiermenge und das empfohlene Schmiermittel angegeben. In Tabelle 2 sind die zulässigen Radial- und Axialbelastungen des Getriebes aufgeführt.

F Le réducteur de type 030 est fourni lubrifié à vie avec de l'huile synthétique. Concernant les positions V5.V6, contactez notre service d'assistance technique. Voir tableau 1 concernant les huiles et les quantités conseillées. Les charges radiales et axiales applicables au réducteur sont précisées dans le tableau 2.

E El reductor tamaño 030 se suministra, lubricado de por vida con aceite sintético. Para las posiciones V5 y V6 contactar con nuestro servicio técnico. Ver tabla 1, para cantidades y aceites recomendados. En la tabla 2, se encuentran las cargas radiales y axiales admitidas por el reductor.

RADIAL AND AXIAL LOADS

Output shaft

Albero di uscita

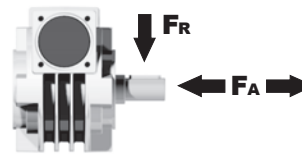

n_2 [min ⁻¹]	FA [N]	FR [N]
200	120	600
150	140	700
100	160	800
75	180	900
50	200	1000
25	250	1250
15	280	1400

Input shaft

albero in entrata

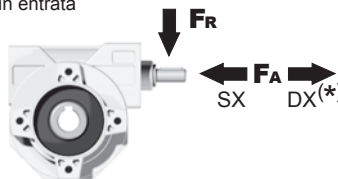

n_1 [min ⁻¹]	FA [N]	FR [N]
1400	20	100

*Strong axial loads in the DX direction are not allowed.
Non sono consentiti forti carichi assiali con direzione DX

tab. 2

P030FB... Basic wormbox
Riduttore base

Gearbox weight
peso riduttore **1.05 kg**

M. flanges	Kit code	øF	A
56B5	K030.4.041	120	61.5
63B5	K030.4.042	140	62.5
56B14	K030.4.046	80	61.5
63B14	K030.4.045	90	62.5

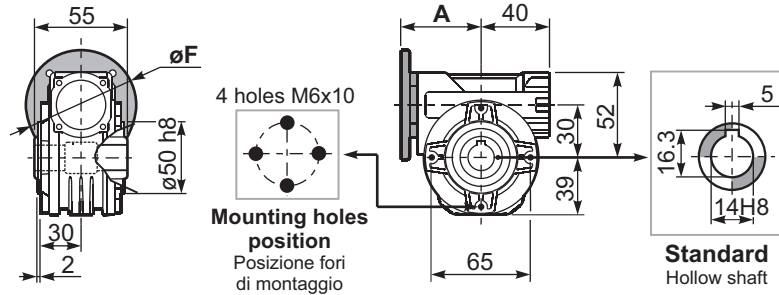

P030PA... Feet
Piedini

P030PB... Feet
Piedini

P030PV... Feet
Piedini

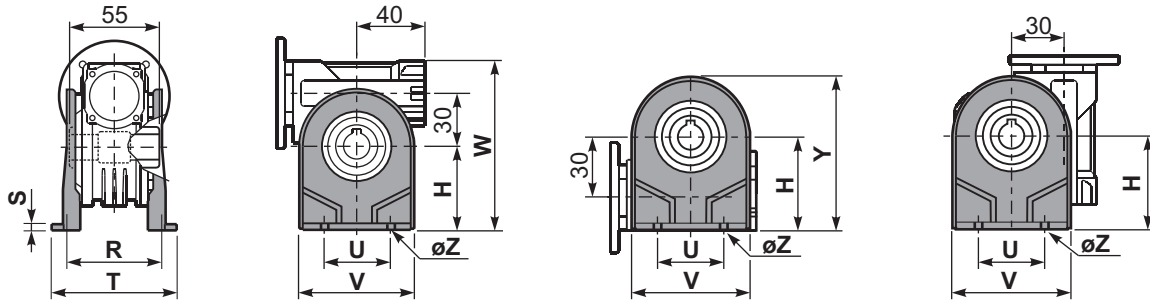

	H	R	S	T	U	V	Y	W	øZ	kit code
type B	55	66	3	87	50	78	94	107	ø6.5	K030.9.022
type S	52	66	3	87	52	90	91	104	ø6.5	KS030.9.023

P030FC... Output flange
Flangia uscita

P030BR... Reaction arm
Braccio di reazione

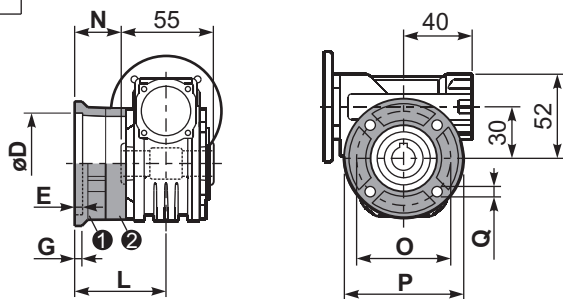

type B	øD	E	G	L	N	O	P	Q	kit code
FC	50 ^{+0.15} / _{+0.05}	6	6	50.5	23	68	80	7	1 K030.9.010 2 -
FL	60 ^{+0.15} / _{+0.05}	6	6	55.5	28	87	110	8.5	1 K045.9.010 2 -

type S	øD	E	G	L	N	O	P	Q	kit code
F1	40 ^{+0.15} / _{+0.10}	3.5	5.5	49	21.5	56	80	6.5	1 KS030.9.012 2 -

P030.....S... Single Shaft
Albero lento semplice

P030.....D... Double Shaft
Albero lento bisp.

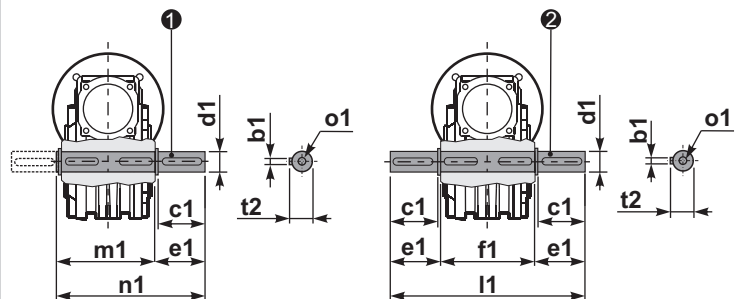

1 kit cod. K030.5.028 type B 2 kit cod. K030.5.029 type B

R030FB... Input shaft
Albero in entrata

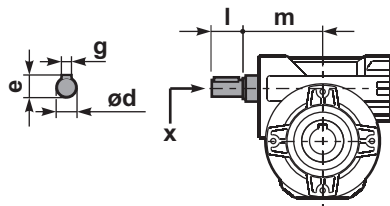

	ød	e	g	l	m	x	kit code
type B	9 h6	10.2	3	20	58	-	K030.5.006 PAM63
type S	-	-	-	-	-	-	-

	b1	c1	d1	e1	f1	l1	m1	n1	t2	o1
type B	5	25	14 ^{-0.005} / _{-0.020}	35.5	55	126	59	94.5	16	M5x14
type S	-	-	-	-	-	-	-	-	-	-